

Hannah-Vogt-Str. 1
D-37085 Goettingen, Germany
Tel +49(0)551-389195-23, +49(0)551-250-3244
Fax +49(0)551-389195-24
info@sensquest.de
www.sensquest.com

Instruction Manual for the Labcycler

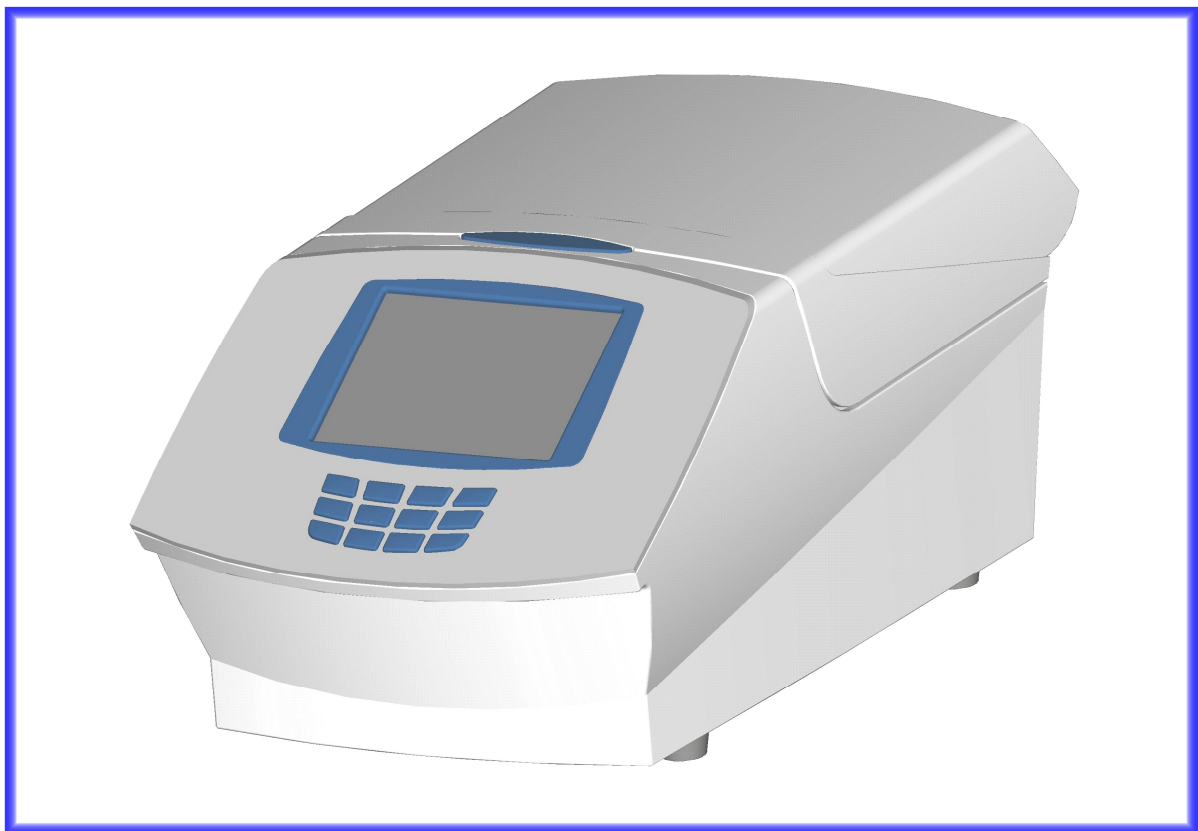

Version: English 2.2

Basics

0.0	General Safety Instruction.....	4
1.1	Introduction.....	5
1.2	Operating - Elements of the Labcycler	5
1.3	Set up.....	5
1.4	Power Supply.....	6
1.5	Initial Start up	6
1.6	Language Set up	7
1.7	Time and Date Set up	7
1.8	Online- Help.....	8
1.9	Window- Structure.....	8

Directory

2.1	Directory New.....	9
2.2	File Edit.....	10
2.3	File Copy.....	11
2.4	File Delete.....	11

Program

3.1	Program New.....	12
3.1.1	Temperature Gradients.....	14
3.1.2	Heating and Cooling Temperature: Ramp	15
3.1.3	Temperature In(de)crements [dT].....	16
3.1.4	Time In(de)crements [dt].....	17
3.2	Program Edit.....	18
3.3	Program Copy.....	19
3.4	Program Delete.....	19
3.5	Program Start.....	20
3.6	Program Stop.....	21
3.7	Program Pause (manual).....	22
3.8	Program Pause (hard coded).....	22
3.9	Program Continue after Power Failure (Re-Start).....	23
3.10	Program Reports.....	23
3.11	Online Monitoring	23

Maintenance and Cleaning

4.1	Block Removal.....	24
4.2	Heated Lid.....	25
4.3	Opening of the Labcycler in Case of an Emergency.....	25
4.4	Cleaning.....	26
4.5	Reaction Tubes and Compatibility.....	27
4.6	Safety Instructions.....	28
4.7	Warranty.....	28
4.8	Technical Data.....	29

5.1	General User Management.....	30
5.2	Set Up User Management.....	30
5.3	General User Management.....	31
5.4	Changing Administrator Password.....	32
5.5	Changing Administrator Properties.....	32
5.6	Deletion of User Management.....	33
5.7	The User or the Standard User.....	34
5.8	User Set Up.....	34
5.9	User Log In & Log Out.....	35
5.10	Changing User Properties.....	36
5.11	User Deletion.....	36
5.12	User Password Changing.....	37
5.13	Protection of Data.....	38
5.14	Remote Log In & Data Transfer between 2 Labcyclers...	39

6.1	Order Information.....	41
7.1	Index.....	42

0.0 General Safety Instructions

- The Labcycler may only be used for the intended purpose as detailed in the **instruction manual**, after familiarization with it.
- **Wear safety gloves against heat** if you work with the Labcycler. Especially the passive lids can store heat.
- Use the Labcycler only in closed rooms with normal air humidity. **Let no liquids inside the device.**
- No objects should be left inside the device because these can get into contact with electrically loaded parts or block movable sections.
- Do never touch hot parts of the Labcycler, especially the heating surface at the lid or the blocks.
- Do not touch mobile parts like the active lid or the ventilation.
- The Labcycler has parts which are under **high voltage**. Attention! The instrument contains high-voltage capacitors which can still be charged to dangerous voltage even a long time after unplugging. **Only trained expert persons may open the device.**
- **Pull the net plug before cleaning.** The device must cool down **30 minutes** before it can be purified.
- Defect devices must be sent to the manufacturer or a service company which is licensed by SensoQuest.
- **Chemical, radioactive or biologic contaminated devices may not be sent to the manufacturer.**

1.1 Introduction

Thank you very much for purchasing the Labcyler. Please, follow the security tips and the regulations of the instruction manual. Each Labcyler is supplied with a mains cable and an instruction manual. The Labcyler was developed to operate biochemical thermal processes in tubes of the size 0.5 ml, 0.2 ml, 96 microtiterplates as well as 384 microtiterplates. The Labcyler has a TFT-touch screen. On connecting the device you find at the top left corner of the touch screen a help function [?] which shows the following steps. In the baseboard below on the right you find another help function which can be accessed by tapping. The contents of this help function are comparable with the contents of the instruction manual.

1.2 Operating - Elements of the Labcyler Basic and Gradient

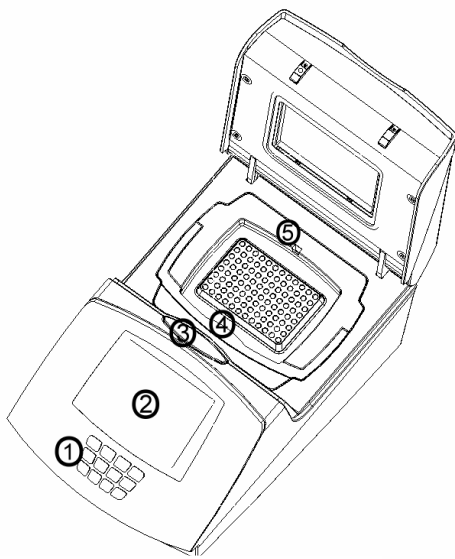

Operating-elements of the front and upper side

- | | |
|---|-------------------------------|
| 1 | Numeric keyboard |
| 2 | TFT-display with touch screen |
| 3 | Lid-unbolting-key |
| 4 | Block-unbolting-handle |
| 5 | Plug for external sensor |

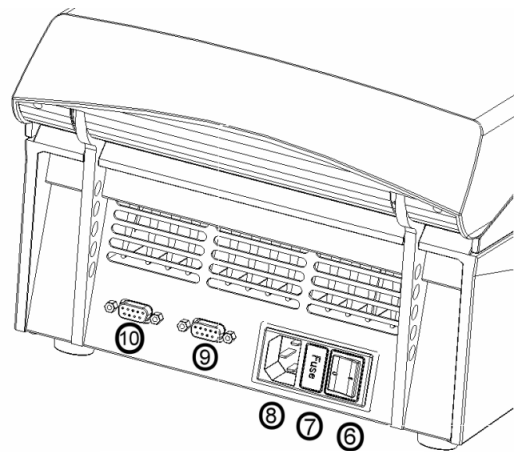

Operating-elements of the back

- | | |
|----|-----------------|
| 6 | Main switch |
| 7 | Primary fuses |
| 8 | Power plug |
| 9 | Aux - Interface |
| 10 | PC - Interface |

The Operating-elements of Labcyler 48 are similar to Labcyler Basic and Gradient. But, there is no numeric keyboard (1), no lid-unbolting-key (2) because the Labcyler 48 has no block changing system, and no plug for an external sensor (5).

1.3 Set up

- If the Labcyler is moved from a cold place to a warmer room, it must not be used for 3 hours to enable any condensing humidity to evaporate.
- The Labcyler should be placed upon a hard flat surface e.g. a table.
- 10 cm space behind the device is necessary.
- Paper, foils, or comparable materials must not be located under the Labcyler.
- There must be enough space at the top of the device to open the lid.

1.4 Power Supply

Connect the Labcycler to a power outlet.

The line voltage of Labcycler Basic and Gradient must be 85 V up to 265 V, for Labcycler 48 200 V up to 265 with a frequency of 50 Hz to 60 Hz. It is not necessary to make any change-over.

1.5 Initial Start up

1. Put the net cable in the net socket [see operating elements Labcycler (8)] which is on the back of the device and the plug in the outlet.
2. Operate the mains switch (6) which is on the back part of the device (position 0 = out; position I = on).
3. The Labcycler carries out a self-test which can be tracked by starting a blue bar.
4. There appears the start window: Block Monitor
5. The Labcycler has a touch screen. The menu strips as well as the input fields are servable with the fingers or a touch-pen.
6. The servable virtual keys are at the bottom of the window: Files, Run, Options, Help
 - The upper area of the window shows the information: temperature, lid-temperature, block, date, and status.  is a help function and is also servable.
7. Now the device is ready for the input of data.

TFT screen after initial start up of the Labcycler

Start window: Labcycler

	Block Monitor	Date
New Cycler	Lid	Temp
Ready		
Temperature		
Block		
Files	Run	Options Help

Servable menu bar (touch-field)

Triple Block (3x21 wells)

	Block Monitor	Date			
Overview	Block 1	Block 2	Block 3	Lid	Temp
Block 3x21					
Info	Graphic				
Ready Temp	Ready Temp	Ready Temp			
Files	Run	Otions	Help		

Servable menu bar (touch-field)

1.6 Language Set up & Name of Labcycler

The Labcycler operates a binary voice system: English or German.

1. Touch lightly in the menu strip of **Options**.
2. There appears another menu strip.
3. Tap on **Settings**.
4. There appears a new window: Settings.
5. Tap on the circle in front of one flag. Choose a language. Tap in the white field. There appears the alphabet. The length of the name can be 11 letters.
6. Tap on **Save**.
7. Tap on **Close**.

Block Monitor		Date	
New Cycler		Lid	Temp
Ready			
Temperature			
Block		Settings	
		Remote Log In	
		Remote Log Out	
		Diagnosis	
Files	Run	Options	Help

Settings			
General	Time	Users	
Device	Input name		←
Language	<input checked="" type="radio"/>	English	
	<input type="radio"/>	German	
		Save	
		Close	
Files	Run	Options	Help

1.7 Time and Date Set up

The new Labcycler has the up to date time and date.

1. Touch lightly in the menu strip of **Options**.
2. There appears another menu strip.
3. Tap on **Settings**.
4. There appears a new window: Settings.
5. Tap on **Time**.
6. Tap on the date or time field.
7. The new input is confirmed by typing **Enter**.
8. Tap on **Save**.
9. Tap on **Close**.

Block Monitor		Date	
New Cycler		Lid	Temp
Ready			
Temperature			
Block		Settings	
		Remote Log In	
		Remote Log Out	
		Diagnosis	
Files	Run	Options	Help

Settings			
General	Time	Users	
Date	Day	Month	Year
Time	h	min	s
		Save	
		Close	
Files	Run	Options	Help

1.8 Online- Help

Two different help functions are available:

1. The icon [?] at the left upper corner indicates possible next actions.
2. The button **Help** in the lower menu bar opens a submenu with following themes:
 - **What's this:** Indicates forthcoming operation possibilities.
 - **Contents:** Provides an overview concerning the help library subdivisions: About this help library, control elements, block monitor, menu files, menu run, menu options, and menu help.
 - **About:** Supplies Labcycler information.

1.9 Window- Structure

1. The main window 'Block Monitor' contains all important information about the block. It is always open and stays in the background. All data are updated continuously even if the window is overlaid by other windows. When the block is running the step listing of the active program or the temperature graph will be shown.
2. Depending on the operation, other windows are open which overlay the main window, e.g. writing a new program. The different windows are explained in the following chapters of the instruction manual.

You can move the windows:

- **Moving:** Tap on the blue menu bar and move your finger during touching the screen. The window will follow your finger until you release the window.
 - **Scaling down:** Tap on the [-] icon. The window is reduced on the size of the title strip. Tap once more on the icon and the window will appear.
 - **Closing:** Tap on the [X] icon and you will close the window. The windows have also a key **Close** with the same function.
3. **Error window:** If you put in values which are out of the limit, the error window will appear. It informs you concerning the valid range of data.
 4. **Scroll bar:** You can move the window contents with the scroll bars. There are the following possibilities:
 - Tap on the bar and move without releasing.
 - It is much faster to tap on the scroll bar. The bar is shifted, and the window content is accordingly displayed.
 - The contents are shifted around exactly on position after typing an arrow key of the scroll bar.

2.1 Directory New

1. Tap on the menu strip **Files**.
2. There appears another menu strip with the functions: New, Edit, Copy and Delete
3. Tap on **New**.
4. There appears another menu strip with the functions: Directory, Program
5. Tap on **Directory**.

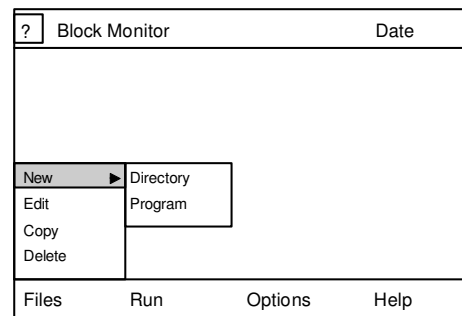

6. There appears a new window: Edit directory name
7. Admit the characters of the folder using the alphabet letters of the touch screen.
8. Ten characters are maximal possible:
 - The first letter is automatically capitalized.
 - Capitalization and use of small letters are controlled by the option fields ABC and abc.
 - Natural numbers can be put in using the numerical keyboard or the option field special.
 - The option field special contains special characters like dot, comma, plus, minus, and so on.
8. Confirm the new name with **Enter**. It appears a new window: Edit directory
9. Please, determine with the icon Group, Person, or Folder the directory ranking.
 - You can enter a comment of 30 letters.

10. Tap on **Save**.
11. There appears a new window: Select target directory
12. Tap on the selected directory (folder, person, group). It will be underlined in blue.
13. Tap on **Save**.
14. Tap on **Close**.

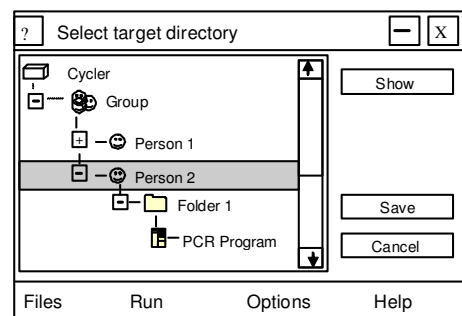

2.2 File Edit

1. Tap on the menu strip **Files**.
2. There appears another menu strip with the functions: New, Edit, Copy and Delete
3. Tap on **Edit**.
4. There appears a new window: Edit
5. Tap on the file you are interested in. This file is marked blue.
 - On the left of group, person, or folder there will be a **[+]** or **[-]** sign.
 - Typing on **[+]** opens the file, type on **[-]** closes the file.
6. Tap on Edit and you can change the information.
7. Tap on **Save**.
8. Tap on **Close**.

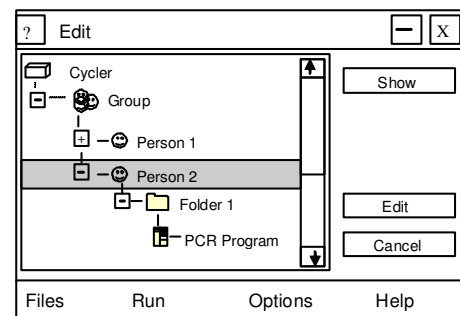
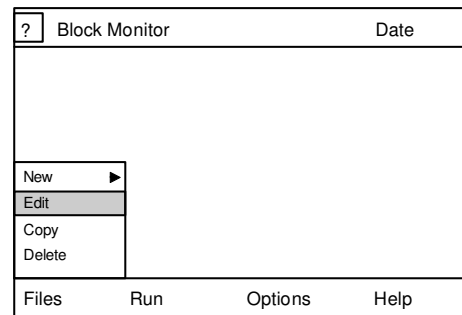

2.3 File Copy

Two devices can be connected with a cable. All files appear in green letters. Only the files in green letters can be copied to the device of origin.

1. Tap on the menu strip **Files**.
2. There appears another menu strip with the functions: New, Edit, Copy and Delete
3. Tap on **Copy**.
4. There appears a new window: Copy: Select source files
5. Type on the file you are interested in. This file is marked in blue.
 - On the left of group, person, or folder there will be a **[+]** or **[-]** sign.
 - Type on **[+]** opens the file, type on **[-]** closes the file.
6. Tap on **Copy** and you can copy the file.
7. Tap on the folder where the file is to be inserted.
8. This folder, group or person is marked blue.
9. Type on **Paste** and the folder is copied.

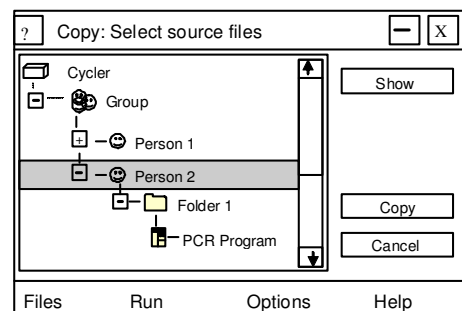
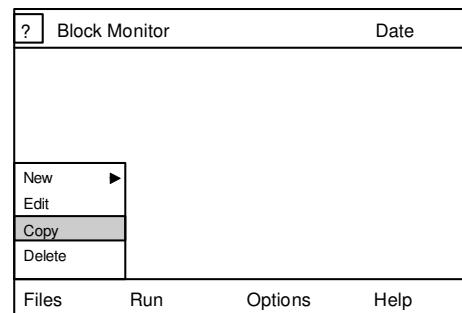

2.4 File Delete

1. Tap on the menu strip **Files**.
2. There appears another menu strip with the functions: New, Edit, Copy and Delete
3. Tap on Delete.
4. There appears a new window: Delete
5. Tap on the file you are interested in. This file will be marked blue.
 - On the left of group, person, or folder, there will be a **[+]** or **[-]** sign.
 - Tap on **[+]** opens the file, tap on **[-]** closes the file.
6. Tap on **Delete**. If the file is empty it will be deleted immediately.
7. A warning window pops up when the file is not empty. Tap on delete in the warning window.
8. Now the file is deleted definitely.

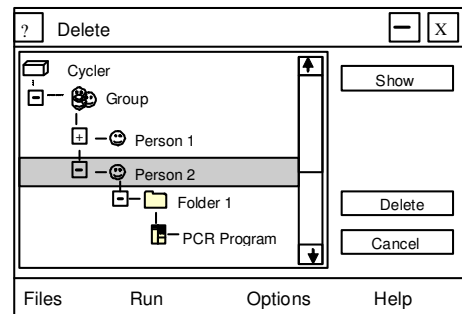
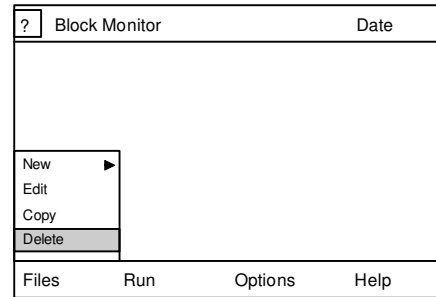

3.1 Program New

1. Tap on the menu strip **Files**.
2. There appears another menu strip with the functions: New, Edit, Copy and Delete
3. Tap on **New**.
4. There appears another menu strip with the functions: Directory, Program
5. Tap on **Program**.
6. There appears a new window: Edit program name
7. Tap on the alphabetic letters on the touch screen. The length of name consists of maximal 10 characters.
 - The first letter is automatically capitalized.
 - Capitalization and use of small letters can be regulated by the option fields ABC and abc.
 - The numbers 0-9 can be put in using the numerical keyboard [see operating-elements of the Labcycler (1)] or the option field special.
 - The option field special contains furthermore special characters: Dot, comma, plus, minus, and so on.
8. Tap on **Enter** to confirm the name of the program.
 - Tapping on Cancel will terminate the process.
9. There appears a new window: Edit program

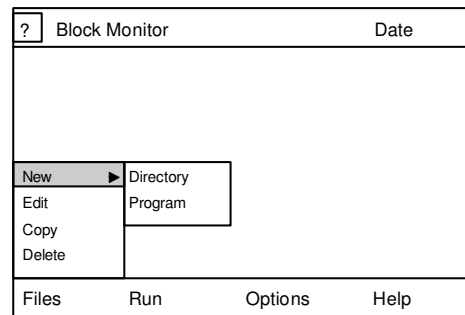

Parameters of the lid can now be put in Under Header and Advanced:

- Heated Lid: on/off
- Preheating: on/off
- Comment: max. 30 characters
- Temperature: – 5.0 °C to 98 °C
- Pressure*: 30 to 120 Newton
- Fast block Control***: on/off
- Block temperature preheating: – 5.0 °C to 99 °C

- **Reaction tubes and recommended pressures (not Labcycler 48):**

Thin wall single tubes:	30-60 Newton
Thick wall single tubes:	30-90 Newton
96-well plates:	90-120 Newton
384-well plates:	100-120 Newton

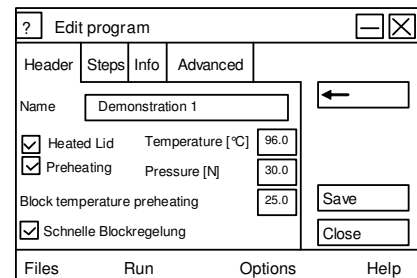

*Only Labcycler Basic and Gradient are adjustable, not Labcycler 48

**Activated Fast block Control has a maximum of acceleration coming to the heating and cooling rate, which are adjusted. Deactivated Fast block Control decrease the acceleration. This could be an advantage for PCR processes with low heating rates, e.g. multiplex PCR.

The pressure can be increased if more reaction tubes are in use. A uniform allocation supports the dispersion of the pressure. Empty reaction tubes in the corners of the block are recommended but are not essential.

10. Tap on **Steps** to put in the program steps.

11. There appears a new window. Tap on the input field to activate it:

- Temp [°C] = Temperature -5.0 °C to 99 °C
- Time = Period of the Step; the input occurs in seconds. Data > 60 **seconds** are automatically calculated in minutes. One dot behind the number is used for minutes, 2 dots are used for hours. Zero [0] is used for endless [∞]. Use the dot function at the display.
-  = Return step is the step to which the program returns after execution of actual step. The entered number must not be larger than the number of the actual step.
- # Passes = Valid range min. 1, max. 99. 1 means that no return will be executed. The value can only be changed, if a return step is entered in the neighbouring field.
- The both scroll bars can be moved by tapping on them.
- If the lower scroll bar moves to the right of the window, it shows the functions gradient (Grad), ramp rates (Ramp), temperature (de)increments (dT), and time(de)increments (dt).

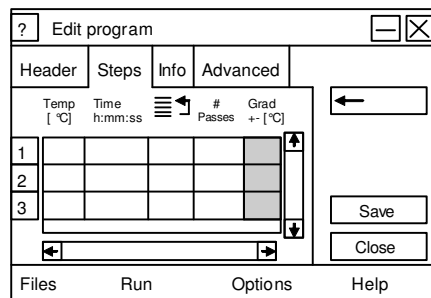

13. If there is no need for using Grad, Ramp, dT, or dt tap on **Save**.

14. There appears a new window: Select target directory.

15. Type on the file you are interested in. This file is marked blue.

- On the left side next to group, person, or folder a there is a **[+]** or **[-]** sign.
- Type on **[+]** opens the file, type on **[-]** closes the file.

16. Tap on **Save**.

17. There appears a new window: Edit program. Tap on **Close**.

18. There appears the window Block Monitor, and you can put in new data or start a program.

3.1.1 Temperature Gradients

Only the Labcycler Gradient, Labcycler 48 Gradient, and Labcycler 48s Gradient have a gradient function, not the Labcycler Basic, and Labcycler 48.

Labcyler Gradient: The Thermoblocks 48, 96, and 384 are gradient capable. The Gradient can be maximal 40 °C (± 20 °C around the middle value).

Labcyler 48 (48s) gradient: The Gradient can be maximal 20 °C (± 10 °C around the middle value).

If the gradient function is in use the maximal temperature is shown in green, the middle in yellow, and the minimal in red. The minimal value is in the extreme left column, the maximal value in the extreme right.

The window **Edit program** must be open.

This window is open when you are working on a new or old program.

1. Tap on column Grad +/-[°C] (grey column) in which the gradient shall be put in.
2. There appears a new window: Gradient Step
3. Put in the value of the gradient in the field at the left upper corner and tap on **Enter**.
4. The Labcycler calculates automatically the temperatures and shows which temperature is in which column. The extreme left column has the minimal value and the extreme right the maximal value.
5. Tap on **Close**.
6. Edit program appears.
7. Tap on **Save**.
8. Tap on **Close**.
9. Block Monitor appears, and you can put in new data or start a program.

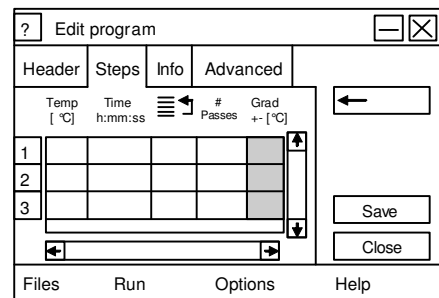

3.1.2 Heating and Cooling Temperature: Ramp

All Labcycler versions have the possibility to regulate the heating and cooling rate: Ramping.
Labcycler Basic and Gradient: Maximal heating rate of Thermoblock 48, 96, and 384 is 4.2 °C/s, maximal cooling rate is 3.6 °C/s. The Triple Block has 2.5 °C/s heating and 2.2 °C/s cooling rate.
Labcycler 48, 48 Gradient and 48s Gradient: Maximal heating rate of Labcycler 48 and 48 Gradient is 3.5 °C/s and Cooling rate 3.2 °C. Labcycler 48s Gradient allows heating and cooling rates in excess of 5 °C.

It is possible to put in a maximal value of 5.0 °C degrees. If the value which is add on is higher than maximal heating and cooling rates the Labcycler will operate with maximum speed.

Minimal heating and cooling rates are 0.001 °C degrees.

If no value is added, the device operates with maximal heating and cooling rates.

The window **Edit program** must be open.

This window is open when you are working on a new or old program.

1. Move the lower scroll bar to the right.
2. Tap on column Ramp [°C/s] (grey column) in which the heating or cooling temperature shall be put in.
3. Values from 0.001 to 5.0 are possible.
 - If the value is out of the range an error window will pop up. Tap on OK.
4. Put in the new value and type **Enter**.
5. Tap on save or put in other program data.
10. Tap on **Save**.
11. Tap on **Close**.
12. There appears the window Block Monitor, and you can put in new data or start a program.

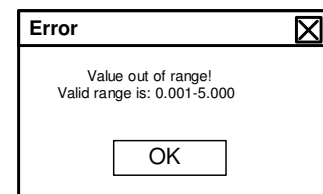
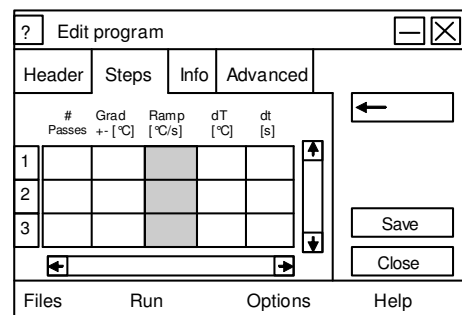

3.1.3 Temperature In(de)crements [dT]

All Labcyclers have these functions.

Temperature in(de)crements are in the range of $-9.99\text{ }^{\circ}\text{C}$ to $+9.99\text{ }^{\circ}\text{C}$ degrees.

Negative data operate a decrement, positive an increment.

Increments over the temperatures of $99\text{ }^{\circ}\text{C}$ degrees are automatically stopped at this point.

Usually temperature decrements are used to reduce the unspecific binding of primers during the first cycles of annealing steps.

The window **Edit program** must be open.

This window is open if you put in a new program or if you work with an old program.

1. Move the lower scroll bar to the right.
2. Tap on column dT [$^{\circ}\text{C}$] (grey column) in which the time shall be put in.
3. Values from $-9.99\text{ }^{\circ}\text{C}$ to $+9.99\text{ }^{\circ}\text{C}$ degrees are possible.
 - If the value is out of the range an error window will pop up. Tap on OK.
4. Put in the new value and type **Enter**.
5. Tap on **Save**.
6. Tap on **Close**.
7. There appears the window Block Monitor appears, and you can put in new data or start a program.

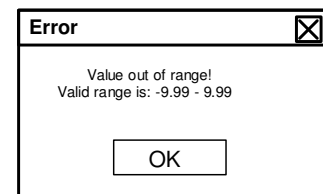
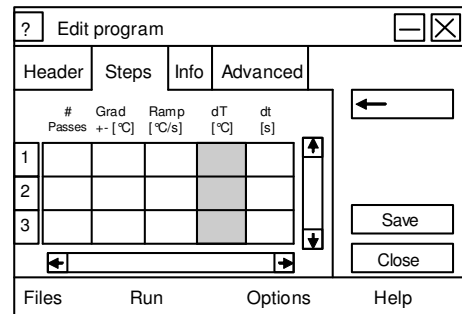

3.1.4 Time In(de)crements [dt]

All Labcycler have these functions.

Time in(de)crements are in the range of $-99.99\text{ }^{\circ}\text{C}$ to $+99.99$ seconds.

Negative data operate a decrement, positive an increment.

Time increments are often used to compensate decreasing activity of polymerase during PCR process.

The window **Edit program** must be open.

This window is open if you put in a new program or if you work with an old program.

1. Move the lower scroll bar to the right.
2. Tap on column dt [s] (grey column) in which the time shall be put in.
3. Values from $-99.99\text{ }^{\circ}\text{C}$ to $+99.99$ seconds are possible.
 - If the value is out of the range an error window will pop up. Tap on OK.
4. Put in the new value and type **Enter**.
5. Tap on **Save**.
6. Tap on **Close**.
7. Block Monitor appears and you can put in new data or start a program.

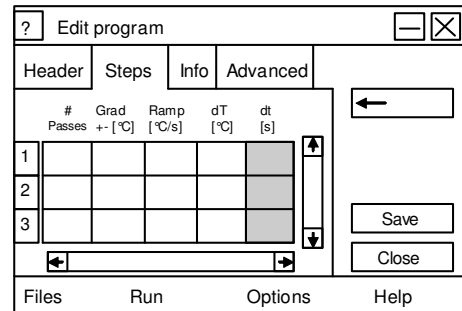

3.2 Program Edit

1. Tap on the menu strip **Files**.
2. There appears another menu strip with the functions: New, Edit, Copy and Delete
3. Tap on **Edit**.
4. There appears a new window: Edit program
5. Tap on the program you are interested in. This program is marked blue.
 - On the left next to group, person, or folder there is a **[+]** or **[-]** sign.
 - Type on **[+]** opens the file, type on **[-]** closes the file.
6. Tap on **Edit** and you can put in the information.
 - For furthermore information possibilities see Program New.
7. Tap on **Save**.
8. Tap on **Close**.

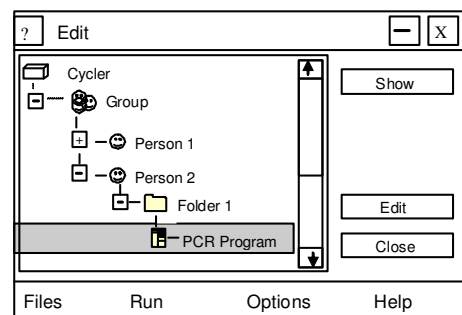
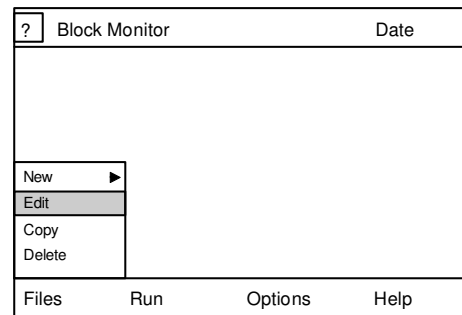

3.3 Program Copy

Two Labcycler can be connected with a RS232 cable. All files will appear in green letters. Only the files in green letters can be copied to the device of origin.

1. Tap on the menu strip **Files**.
2. There appears another menu strip with the functions: New, Edit, Copy and Delete
3. Tap on **Copy**.
4. There appears a new window: Copy: Select source files
5. Tap on the program you are interested in. This program is marked blue.
 - On the left next to group, person, or folder there is a **[+]** or **[-]** sign.
 - Type on **[+]** opens the file, type on **[-]** closes the file.
6. Tap on **Copy**.
7. Tap on the folder, the person or the group in which the copied program should be placed.
8. This folder, person, or group is marked blue.
9. Tap on **Paste**.

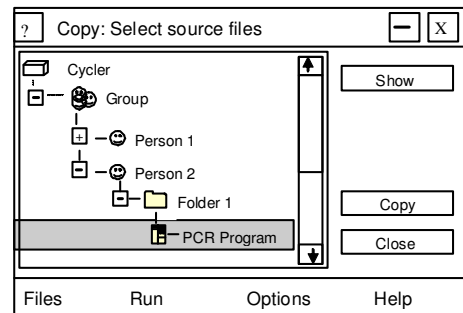
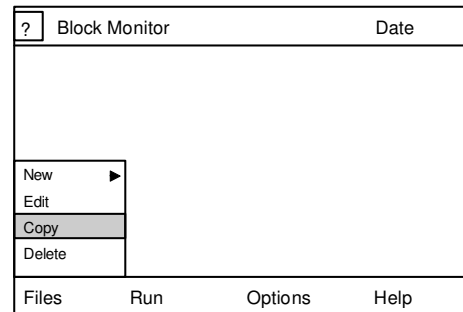

3.4 Program Delete

1. Tap on the menu strip **Files**.
2. There appears another menu strip with the functions: New, Edit, Copy and Delete
3. Tap on **Delete**.
4. There appears a new window: Delete
5. Tap on the program you are interested in. This program is marked blue.
 - On the left , next to group, person, or folder there is a **[+]** or **[-]** sign.
 - Type on **[+]** opens the file, type on **[-]** closes the file.
6. Tap on **Delete**.
7. Tap on **Close**.

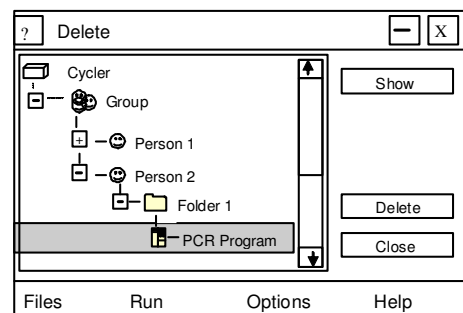
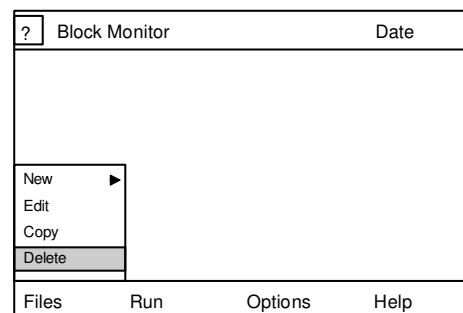

3.5 Program Start

Please, pay attention and put the tubes uniformly into the block. We advise to put empty tubes in the corners of each Thermoblock system.

If you work with the Triple Block you can start each sub-block at different points of times. You can open the device while other sub-blocks are running, but the active lid should not be longer open than 3 minutes. During the opening the passive lids store the heat and inhibit the condensing effects in the cap. It is necessary to wear protective gloves against heat while the lid is open.

1. Tap on menu strip **Run**.
 - While working with the Triple Block it appears a menu bar concerning the choice of block. Choose block 1, 2, or 3. The activated block will be marked in white.
2. There appears another menu strip with the functions: Start, Stop now, Pause, Continue, and Reports.
 - Triple Block: The protocol function is at the menu bar blocks.
3. Tap on **Start**.
4. There appears a new window: Start.

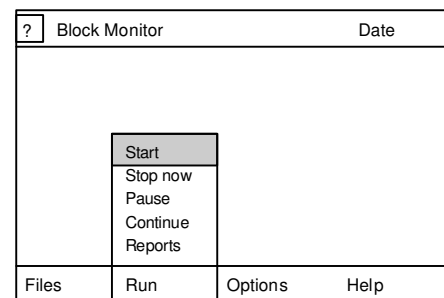

5. Type on the program you are interested in. This program is marked blue.
 - On the left, next to group, person, or folder there is a **[+]** or **[-]** sign.
 - Type on **[+]** opens the file, type on **[-]** closes the file.
 - The button Start now shows a green light.
6. Tap on **Start now**. The electric lid is moving down. A warning window appears.
7. The program is starting.
 - The upper area of the touch screen shows the rest of running time.
 - Tap on **Step Listing** and you can see which step is just active.
 - Tap on **Graphic** and you can see the temperature profile.
 - Tap on **Info** and you are getting general information.

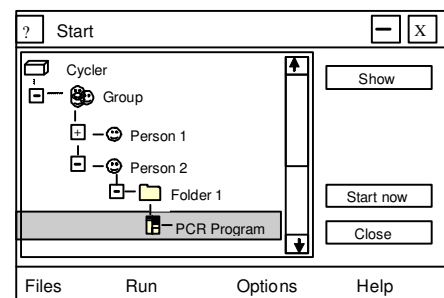

3.6 Program Stop

If you work with the Triple Block you can stop each sub-block at different points of times. You can open the device while other sub-blocks are running, but the lid should not be longer open than 3 minutes. During the opening the passive lids store the heat and inhibit the condensing effects in the cap. It is necessary to wear protective gloves against heat.

1. Tap on menu strip **Run**.
2. There appears another menu strip with the functions: Start, Stop now, Pause, Continue, and Reports.
3. Tap on **Stop now**.
4. The program stops and the electric lid moves up.

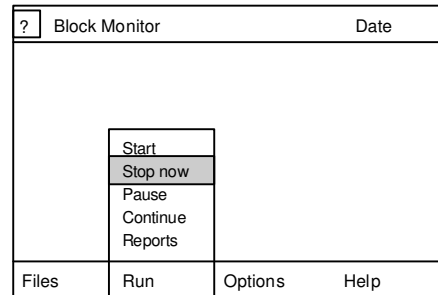

3.7 Program Pause (manual)

You can interrupt a process at any time by using the key **Pause**.

1. A program is still running.
 - If you work with the Triple Block you must choose the block by tapping on the menu bar.
2. Tap on menu strip **Run**.
3. There appears another menu strip with the Functions: Start, Stop now, Pause, and Reports.
4. Tap on **Pause**.
5. The lid moves up. A warning window appears.
 - The temperature is constant at that step where the PCR process is.
6. Tap on **Run** and type **Continue**.
7. The pause is finished, and the lid moves down. The program goes on.

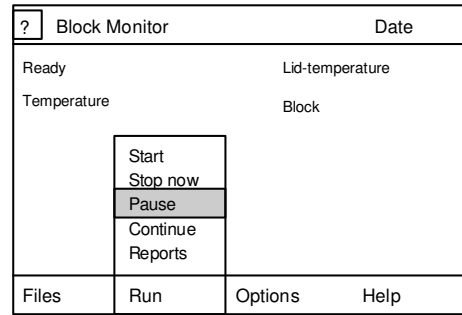

3.8 Program Pause (hard coded)

1. You will get a hard coded pause if you put in a zero (0) in the column time.
2. The sign ∞ appears signifying 'infinity'.
3. If the program accomplishes this step the lid moves up.
4. The temperature remains steady.
5. Tap on **Run** and **Continue** and the pause is finished.
6. The lid moves down and the program goes on.

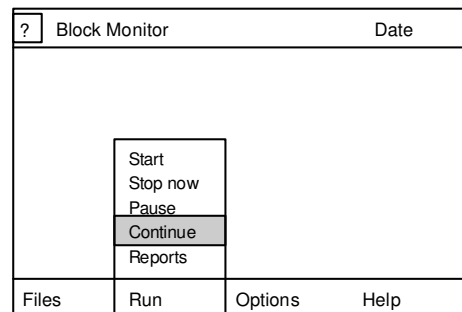
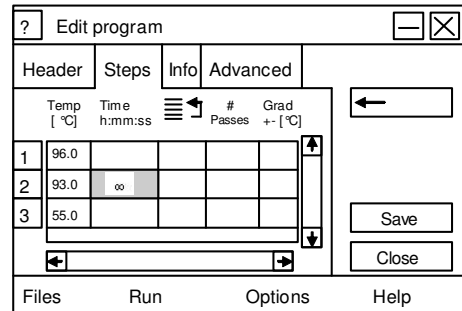

3.9 Program Continue after power failure (Re-Start)

If a power failure appears during a program expiry or the device in the main switch is switched off, the program will automatically continue, as soon as the power is switched on.

1. The block will immediately re-start.
2. It appears an Info-window.
3. Tap on **OK**.
4. The program is still running.

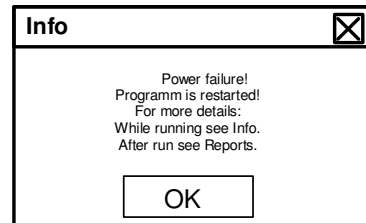

It is possible that unspecific agglomerations are generated during the temperature has decreased. To reduce this problem the Labcycler starts automatically with the highest temperature of the last loop (denaturing step). If the power failure has interrupted a normal step and not a loop, the Re-start goes on at this step.

If the interruption stops longer than four days, a continuation will be renounced.

3.10 Program Reports

1. Tap on **Run**.
2. Tap on **Reports**. You will see a new window with the last program runs. The last program is marked blue.
3. Tap on the program you are interested in. This program will be marked blue.
4. Tap on **Show**. A window appears and will show the information concerning the program of interest.
5. Tap on **Close**. The window Reports is closed.

3.11 Online Monitoring

You can monitor the graphic while the PCR process is running. The rest of run time is shown to you. Step-list is showing the step which is active. How long this step is active is also shown in the screen window. If the gradient function is in use the maximal temperature is shown in green, the middle in yellow, and the minimal is in red. The Info is showing other features like day and time of starting and unexpected events.

Triple Block: The overview shows all three sub-blocks. It is possible to see all graphics at the same time. The graphic of the left block is shown in red, of the middle block in yellow, and of the right block in green. Nevertheless it is possible to see only one graphic or information concerning one block if you tap on Block 1, Block 2, or Block 3.

4.1 Block Removal (only Labcycler Basic and Gradient)

To Remove the Block

1. Switch off the device.
 - The Labcycler is not damaged when the block is taken off during power on. After insertion the new block the device makes an analytic self test.
2. Open the device completely with the lid-unbolting-key [see operating elements (3)].
3. Seize the grip at the middle of the unbolting-handle (4) and move it vertically upwards.
 - The block is disconnected during this operation.
4. Move the block vertically out of the lifting hole.
 - Do not put anything at the top of the block.
 - Do not put anything in the lifting hole.
 - Do not start a program.
 - Do not grip into the ventilators.

To Insert the Block

1. Switch off the device.
2. Hold the block at the unbolting-handle [see operating elements (4)] so that the metal rail is in the direction of the touch screen.
 - The block was constructed in a way that an incorrect insertion is not possible.
3. Insert the block vertically into the lifting hole.
5. If the connectors contact their counterpart move the lid-unbolting-key carefully down. Block and device are connected after this process is finished.
6. Apply power.
7. The device makes an analytic self test.
8. The device is ready for use.

4.2 Heated Lid

Active Lid while thermoblock 48, 96 und 384 are in use.

The heated lid is automatically controlled by the program in use (see program new).

The heated lid is deactivated automatically if the difference of temperature between the lid and the block is 75 °C. The lid can be moved up (only Labcycler Basic and Gradient) whilst running a program when a pause is set (see program pause by hand or programmed).

The heated lid can be moved without running a program:

1. Tap on **Options**. There appears a new menu bar.
2. Tap on **Diagnosis**.
3. Tap on **Lid down**.
 - The movement of the lid can be stopped by typing Lid stop or Lid up.
4. Tap on **Lid up** and the lid is moving up.

Active and passive lids while the Triple Block is in use.

It is necessary to work with three passive lids if the Triple Block is in use! It is necessary to wear safety gloves against heat while working with the Triple Block and the passive lids. The passive lids conduct the heat from the active lid to the caps. Therefore while the device is open they inhibit the condensing effect.

The device can be opened to put probes inside, or to take out some probes. The head capacities of the passive lids inhibit the condensing effects optimal for 3 minutes. After this time the lids are cooling slowly down. Therefore condensing effects are increasing proportional to the opening time. Fast working while the PCR processes are running is necessary!

The active lid will be deactivated if the temperature difference between the last active sub-block and the lid is more than 75 °C.

Auto mechanic Lid while Labcycler 48 is in use

The lid of Labcycler 48 is mechanically fixed and can be opened while a PCR process is still running.

4.3 Opening of the Labcycler in Case of an Emergency

This is only valid for Thermoblock 48, 96, and 384. The device can be opened in the extreme emergency when the lid is driven down.

1. Check, whether there is an emergency or not. Is there any other possibility to move the electric lid up (see heated lid)?
2. If there is no alternative possible, use the lid-unbolting-key [see operating-elements of Labcyclers (3)]. Press down the lid with the other hand to relieve the bolts.
3. Open the device slowly!
 - While opening the heated lid or the sealing frame can touch the reaction tubes.
4. Check after the opening whether the lid is electronic controllable or not (see heated lid).
5. If the heated lid is not movable please contact SensoQuest or an authorized distributor.

4.4 Cleaning

Cleaning of the touch screen

Fingerprints can be removed by cleaning with a humid soft cloth (water or 70% ethanol). Do not use cleaning agents with ammonia or abrasive. Do not clean with solutions because this can flow behind the touch screen.

- Use a humid soft cloth.
- Glass cleaner without ammonia can be used.
- To avoid fingerprints a touch pen can be used.
- 70% ethanol can be used for cleaning and disinfection.

Cleaning of the device and the block

- Pull the net plug before starting purification. The lid and silver block must be allowed to cool down. No liquids must enter inside the device.
- Clean with a humid soft cloth. Use soft cleaning agents, water or 70% ethanol and no aggressive substances or abrasive. Especially avoid scratching of the block and the surface of the heated lid and the touch screen.
- Occasionally clean the ventilation grille with vacuum cleaner.
- Take the block out of the machine before cleaning. The block can be cleaned with a very low humid cloth. Avoid liquids entering the block.
- The wells can be purified with cotton buds.

4.5 Reaction Tubes and Compatibility

The Thermoblocks 48, 96, and 384 are compatible to the most standard test tubes and microtiterplates. If one block is in use it is necessary to work with the same tubes. This is especially important for the three sub-blocks of the Triple Block. We recommend flat cap tubes, especially when the Triple Block is used. All blocks should be loaded symmetrically. It is necessary to put empty tubes in the corners of the blocks or sub-blocks (e.g. Triple Block). We recommend the following tubes for Triple Block application: 72.737.002, Multiply-Pro, 0.2 ml. If stripes are used one tube must cut off at one side and the overhang must be cut off at the other side. Pay attention that the passive lids are in the right position!

Compatibility 48 well block, 0.5 single tubes

Abgene	AB-0350
Bio-Budget Technologies GmbH	my-Budget PCR-Tubes 0.5 ml, cat. no. 20-3-110-50-0
Greiner bio-one	Cat. No. 682201
Kisker Biotech	G-005 (serial)

Compatibility 96 well block, 0.2 single tubes

Abgene	AB-0620
Bio-Budget Technologies	my-Budget PCR-Tubes 0.2 ml, cat. no. 20-3-010-50-0
Greiner bio-one	Cat. No. 683201
Kisker Biotech	G-001 (serial)

Compatibility 96 well block, stripes

Abgene	AB-0266, AB-0624, AB-0648, AB-0866, AB-1183
Bio-Budget Technologies	my-Budget 8er-Strips, cat. No. 30-SP-0020
Greiner bio-one	Cat. No. 673210
Kisker Biotech	G-002 (serial)

Compatibility 96 well block, plates

Abgene	AB-0600, AB-0700, AB-0731, AB-0800, AB-900, AB-990, AB-1100, AB-1300, AB-1400, AB-1500, AB-1900 AB-2800
Bio-Budget Technologies	my-Budget "96 well" PCR-plates, cat. no. 30-SP-9600 my-Budget "96 well" PCR-plates, (Skirted), 30-SP-0037 my-Budget "96 well" PCR-plates, (Semi-Skirted), 30-SP-0127 my-Budget "96 well" PCR-plates, (Low Profile), 30-SP-0029
Greiner bio-one	Cat. No. 651501, 651550, 651560, 651570, 651585, 652201, 652270
Kisker Biotech	G-060 (serial)
Sorenson	Semi-Skirt 96 PCR plate , Skirted 96 PCR plate, 96-well ultra plate

Compatibility 384 well block, microtiterplates

Abgene	AB-0937, AB-1111, AB-1384, TF-0384 Sealing Foil 0558
Bio-Budget Technologies	My-Budget "384 well" PCR-plates, 30-SP-0448
Greiner bio-one	785201, 785290
Kisker Biotech	G-034
Sorenson	384-well PCR plate NX

4.6 Safety Instructions

- The Labcycler may only be used for the intended purpose as detailed in the instruction manual, after familiarisation with it.
- Use the Labcycler only in closed rooms with normal air humidity. Let no liquids inside the device.
- No objects should be left inside the device because these can get into contact with electrically loaded parts or block movable sections.
- Do never touch hot parts of the Labcycler, especially the heating surface at the lid or the silver block.
- Do not touch mobile parts like the heating lid or the ventilation.
- The Labcycler contains parts which are under high voltage. Attention! The instrument contains high- voltage capacitors which can still be charged to dangerous voltage even a long time after unplugging. Only trained expert persons may open the device.
- Defect devices must be sent to the manufacturer or a service company which is licensed by SensoQuest.
- Chemical, radioactive or biologic contaminated devices may not be sent to the manufacturer.

4.7 Warranty

Providing the Labcycler has been used correctly, if within a **period of two years** from the date of purchase of SensoQuest or an authorised SensoQuest specialist supplier, this product is deemed faulty, it will be repaired or replaced according to judgement by SensoQuest. The warranty is not valid in the following cases in which the customer is responsible to pay for the repair costs even if the faults occur within the warranty period.

- Any fault which is caused by improper operation.
- Any fault which is caused by unprofessional repair, improper use, or incorrect cleaning.
- Any fault which is caused by poor transport, dropping, or improper storage after buying the product.
- Any fault, which is caused by fire, earthquake, flooding, lightning, or other natural disaster.
- The whole responsibility of SensoQuest is restricted to repair or displacement of the Labcycler. Every liability for indirect or secondary damages of every kind which have originated to the customer or which he has suffered on reasons of a lack of the product is excluded.

4.8 Technical Data

Device	Labcyler Basic & Gradient	Labcyler 48, 48s, Gradient
Line voltage	85 V to 265 V without switching, 50 to 60 Hz	200 V to 265 V without switching, 50 to 60 Hz
Power consumption	Maximum 350 W, standby 25 W	Maximum 180 W, standby 25 W
Noise	Idle 38 dBA, typical 44 dBA, maximum 48 dBA	
Interfaces	RS232	
Heated lid	Electrically moving, temperature and pressure programmable	Automatic
Lid pressure	Programmable from 30 to 120 Newton	Automatic, not programmable
Dimension	Length = 44 cm, width = 25 cm, height = 20 cm	Length = 37 cm, width = 20 cm, height = 16 cm
Weight	11,5 kg	7,8 kg
Display	TFT illuminated colour display ¼ VGA, 5.7" diagonal, 320 x 240 = 76800 Pixel, touchscreen	TFT illuminated colour display ¼ VGA, 5.7" diagonal, 320 x 240 = 76800 Pixel, touchscreen
Keyboard	Numeric silicone keys, virtual keys on the touchscreen depending on the context	Virtual keys on the touchscreen depending on the context
Languages	English, German	
Programs	680 5-step-programs, or at least 3000 steps	
Protocol function	The last 16 program runs can be displayed any time.	
Password protection	For 64 User	
Temperature	- 5.0 °C to 99.0 °C	
Homogeneity	± 0.25 °C at 55 °C, ± 0.40 °C at 95 °C	
Control accuracy	± 0.01 °C/s	
Ramp rate	0.001 °C/s to 5.0 °C/s	
De(In)crements	Temperature ± 9.99 °C, time ± 99.99 seconds	
Blocks	<p>Electroformed gold plated silver, gradient capable blocks: 40 °C, ± 20 °C from the left to the right</p> <p>Heating rate: 4.2 °C/s, cooling rate 3.6 °C/s</p> <p>Thermoblock 48: 48-Well, 0.5 ml tubes, 8 zoning gradient</p> <p>Thermoblock 96: 96-Well, 0.2 ml tubes, & microplates, 12 zoning gradient</p> <p>Thermoblock 384: 384-Well, 384 microplates, 24 zoning gradient</p> <p>Triple Block 3x21: Aluminium</p> <p>3 independent sub-blocks with 3 x 21 wells, 0.2 ml tubes, 3 passive Lids as condensing inhibitor, 3 different PCR processes at the same time, not gradient possible</p> <p>Heating rate: 2.5 °C/s, cooling rate 2.2 °C/s</p>	<p>Labcyler 48 & 48 Gradient:</p> <p>Aluminium,</p> <p>Thermoblock 48: 48-Well, 0.2 ml tubes, 8 zones</p> <p>Gradient capable, 20 °C, ± 10 °C from the left to the right</p> <p>Heating rate: 3.6 °C/s, cooling rate 3.1 °C/s</p> <p>Labcyler 48s Gradient:</p> <p>Electroformed gold plated silver, gradient capable</p> <p>Thermoblock 48: 48-Well, 0.2 ml tubes, 8 zones</p> <p>Gradient capable: 20 °C, ± 10 °C from the left to the right</p> <p>Heating rate: ~5.0 °C/s, cooling rate ~5.0 °C/s</p>

5.1 General User Management

Every Labcyler has the option to work with a user management. New devices have an inactive user management. All data, programs and folder can be used by anyone.

The user management is used to contain access for specific person. Folders, groups and persons can be saved with a password protection that only specific persons can see or use them.

The first registered user is defined as main administrator with all rights and cannot be deleted. The administrator or with short patterns Main Admin gives any user specific rights. Only programs which are saved in a folder, person, or group can be protected. All other programs are any time for anyone useable.

Up to 63 users with or without administrative rights can be stored. Users can be allocated to working groups.

5.2 Set Up User Management

1. Tap on the menu strip of **Options**.
2. There appears another menu strip with Settings, Remote Log in, Remote Log out and Diagnosis.
3. Tap on **Settings**.
4. There appears a new window. Tap on **Users**.
5. There appears a new window: Tap on **Configure User Management**.

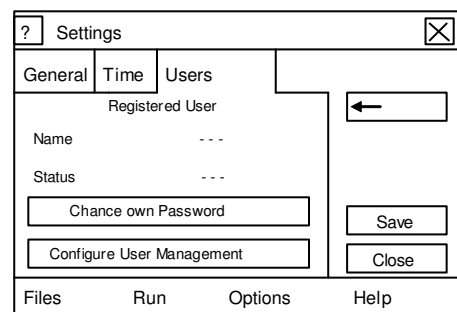

The User Management allows saving data. Folders can be saved for unwished access. The administrator has the right to administrate the user list.

6. Tap on **Continue**.
7. Add your password at **New Password** And **Retype** it. The password can contain 8 letters.
8. Tap on **Enter**.
9. Tap on **Close**.

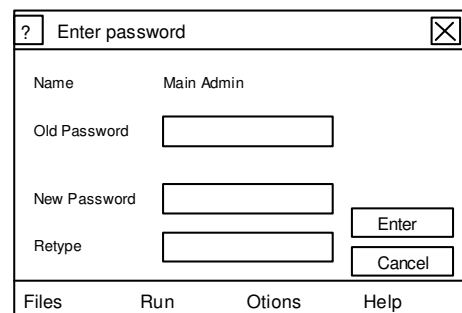

The User Management is active and the administrator is registered. You are at the same time logged in as administrator, and you can set up furthermore configuration.

Important: Please, write down the administrator password and save it. You cannot make important changes in the use management without any knowledge of the password. In urgent cases stay in contact with your vendor.

5.3 Administrator Log In & Log Out

The administrator has access of the whole directory. He has the right to set up new passwords and to allocate rights.

Log In

1. Tap on **Log In** at the right upper corner of the screen.
2. It appears a new window. Main Admin has a blue background. This is the administrator. The scroll arrow allows other users the Log In.
3. Tap on the field password. There appears a new window: Enter password.
4. Put in your password. You can use the numeric keyboard and the touch screen.
5. Tap on **Enter**.
6. There appears a new window: Log In
7. Tap again on **Enter**.
8. It appears a new window: Log In was successfully.

The screenshot shows a window with a title bar containing a question mark icon, 'Date, time', 'User:', and a 'Log In' button. Below the title bar, the text 'New Cyclor' and 'Lid temperature' is visible. The main area contains the words 'Ready', 'Temp', and 'Block' stacked vertically. At the bottom, there is a navigation bar with the labels 'Files', 'Run', 'Options', and 'Help'.

The screenshot shows a 'Log In' dialog box with a title bar containing a question mark icon, 'Log In', and a close button. The dialog has a 'User' label with a dropdown menu showing 'Main Admin' and a downward arrow. Below it is a 'Password' label with an empty text input field. At the bottom, there are two buttons: 'Cancel' and 'Enter'. The dialog also has a navigation bar at the bottom with the labels 'Files', 'Run', 'Options', and 'Help'.

Password forgotten?

In case of a forgotten administrator password it will be necessary to stay in contact with the vendor of the Labcyclor.

Log Out

1. Tap on **Log Out** at the right upper corner of the screen.
2. It appears a new window: User Logged off.

The administrator can set up an automatic log out. Automatic log out is possible after following minutes: 60, 30, 10, 3, or never. The automatic log out occurs while a program is running. The program will not be stopped while the log out. Only the user or the administrator can stop a password protected program run.

5.4 Changing Administrator Password

The logged in administrator can change the password.

1. Tap on the menu strip of **Options**.
2. There appears another menu strip with **Settings**, **Remote Log in**, **Remote Log out** and **Diagnosis**.
3. Tap on **Settings**.
4. There appears a new window. Tap on **Users**.
5. There appears a new window. Tap on **Change own Password**.
6. Put in the new password.
7. Tap on **Retype** and put in the new password again.
8. Tap on **Enter** and then **Save**.
9. Tap on **Close**.

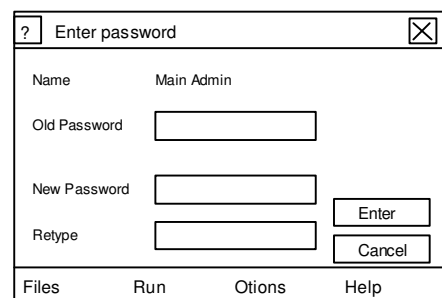
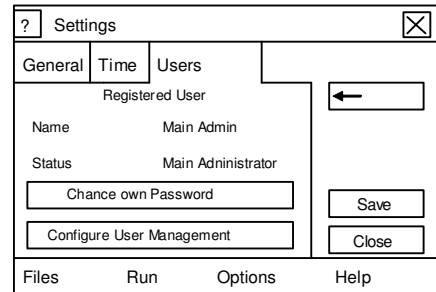

After logging out you can only log in with the new password.

5.5 Changing Administrator Properties

The administrator can later change following pattern: Name, automatic Log Out and password.

It is not possible to deactivate the main administrator rights. But it is possible to set down a user from administrator to a standard user. These will reduce the rights of the user, and maybe its rights to get access of password protected data.

5.6 Deletion of User Management

User data can be deleted by logged in administrator. The deletion of the complete user management resulted in the deletion of all user authorization. The complete directory is conserved. All programs are usable for everyone after deactivation. If a new user administration is wished a new administrator must be accessed.

1. Tap on Options at the menu bar.
1. There appears another menu strip with Settings, Remote Log in, Remote Log out and diagnosis.
2. Tap on **Settings**.
3. There appears a new window. Tap on **Users**.
5. There appears a new window. Tap on **Configure User Management**.
6. Tap on Delete all User Data. All authorization will deactivated after finishing this process. Programs will no be password protected.
7. It appears a new window.
8. Put in the password of the administrator.

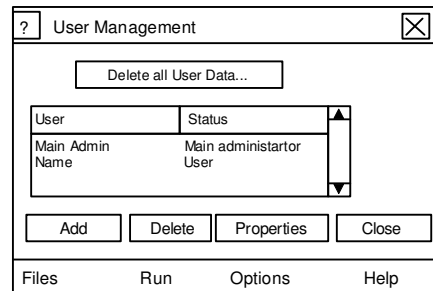
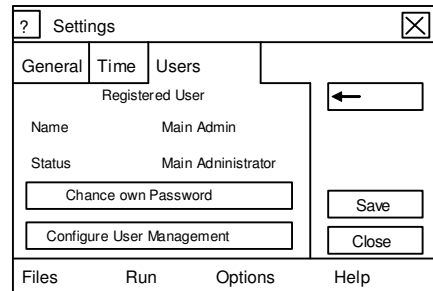

The user management is deleted and all programs can be used by anyone.

5.7 The User or the Standard User

Users are individuals who use the Labcycler. A user is set up by the administrator. Generally a user is registered as Standard User. But the user can also get the same rights as an administrator has. Unregistered users can work as well; they are members of the group ,EVERYONE'.

Registered users can log in with a password. Each user can be a member of three working groups. The passwords can be changed from the administrator or from the user. The administrator can give the user following rights: a) reading and starting b) changing and deleting c) changing rights.

5.8 User Set Up

1. Tap on **Options** at the menu bar.
2. There appears another menu strip with Settings, Remote Log in, Remote Log out and Diagnosis.
3. Tap on **Settings**.
4. There appears a new window. Tap on **Users**.

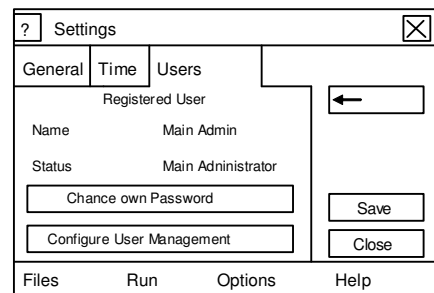

5. There appears a new window. Tap on **Configure User Management**.
6. There appears a new window. Users are shown under Main Admin.
7. Tap on **Add**. There appears a new window. You can select the type of user: Person or group. Tap on **Enter**.
8. It appears a new window. Put in the name of the new user. Tap on **Enter**.

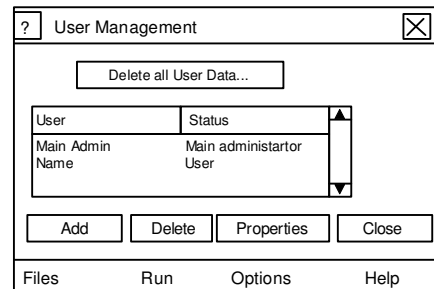

9. Put in the new password. Retype the password and tap on 2x with **Enter**.
10. It appears a new window. The user can get administrator rights, but it is recommended to give only the administrator or a few users administrator rights. Automatic Log Out can set up as followed: Never, 3 min, 10 min, 30 min, and 1 hour.
11. Tap on **Save** and **Close**.

5.9 User Log In & Log Out

Log In

1. Tap on **Log In** at the upper corner of the screen.
2. There appears a new window.
3. There appears Main Admin blue deposited.
4. Tap on the **scroll arrow**.
5. You can choose on of the user. Tap on the user.
6. Add in the user specific password. You can use the numeric keyboard as well as the touch screen keyboard. Tap on **Enter**.
7. There appears a new window: Log-In. Tap on **Enter**.
8. It appears a new window for a short moment: Login successful.

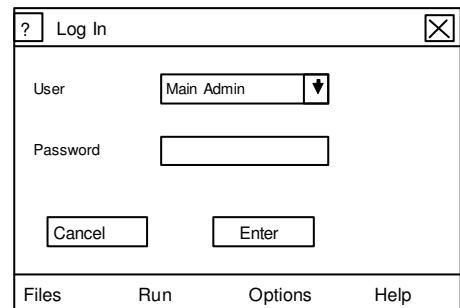

The screenshot shows a window titled "Log In" with a close button in the top right corner. It contains a "User" label next to a dropdown menu showing "Main Admin" with a downward arrow. Below it is a "Password" label next to an empty text input field. At the bottom, there are two buttons: "Cancel" and "Enter". A menu bar at the very bottom contains the items "Files", "Run", "Options", and "Help".

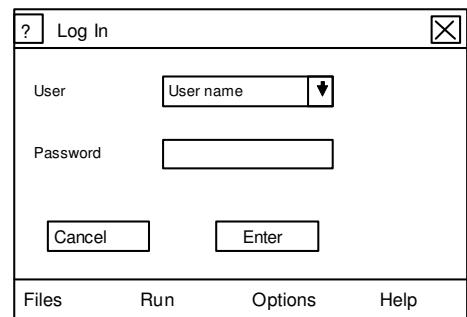

The screenshot shows a window titled "Log In" with a close button in the top right corner. It contains a "User" label next to a dropdown menu showing "User name" with a downward arrow. Below it is a "Password" label next to an empty text input field. At the bottom, there are two buttons: "Cancel" and "Enter". A menu bar at the very bottom contains the items "Files", "Run", "Options", and "Help".

Log Out

1. Tap on **Log Out** at the upper corner of the screen.
2. There appears a new window User logged off.
3. Tap on **OK**.

Automatic log out is possible after following minutes: 3 min, 10 min, 30 min, 1 hour, or never. The automatic log out occurs while a program is running. The program will not be stopped while the log out. Only the user or the administrator can stop a password protected program run. Programs are closed while automatic Log Out. Is there any open data which was not saved the window is closed but hidden. Only the user or the administrator will see this file after logging in again. While this open file is still open no other file will be opened. The automatic log out occurs while a program is still running. Only the user or the administrator can stop the program run before it ends. Other users cannot stop the program run.

5.10 Changing User Properties

The administrator can change subsequently following user features: Name, standard- or administrator status, automatic Log Out, password, and membership. The new standard user password can be set up without knowing the old one. If the name of a person is changed the access rights will be in spite of this constant. Each user name can be used once.

Please consider that the subsequently transformation of an administrator to a standard user possible limited its rights.

If there is a group registered you can register persons to this membership. 3 memberships are for each person possible.

5.11 User Deletion

Users are deleted by the administrator. The administrator must be logged in.

1. Tap on **Options** at the menu bar.
2. There appears another menu strip with Settings, Remote Log In, Remote Log Out and Diagnosis.
3. Tap on **Settings**.
4. There appears a new window.
Tap on **Users**.
5. There appears a new window. Tap on **Configure User Management**.
6. Tap on the User which shall be deleted.
This user is blue deposited.
7. Tap on **Delete** and then **Continue**.
8. Tap on **Close** twice.

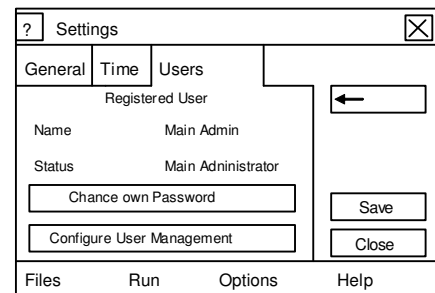

The user is deleted.

5.12 User Password Changing

The administrator can change any password. If one use has forgotten the password, the administrator can set up a new one without knowing the old one. The user can change only there own password.

1. Tap on **Options** at the menu bar.
2. There appears another menu strip with **Settings**, **Remote Log In**, **Remote Log Out** and **Diagnosis**.
3. Tap on **Settings**.
4. There appears a new window.
Tap on **Users**.
5. There appears a new window: **Settings**.
Tap on **Change own Password**.
6. There appears a new window: **Enter password**.
Put in your old and new password and retype it.
Tap on **Enter**.
7. Tap on **Save** and then on **Close**.

The screenshot shows a window titled "Settings" with a close button in the top right corner. Below the title bar are three tabs: "General", "Time", and "Users". The "Users" tab is selected. The main content area shows "Registered User" with a left-pointing arrow button. Below this, the "Name" is "Main Admin" and the "Status" is "Main Administrator". There are two buttons: "Chance own Password" and "Configure User Management". On the right side, there are "Save" and "Close" buttons. At the bottom, there is a menu bar with "Files", "Run", "Options", and "Help".

The screenshot shows a window titled "Enter password" with a close button in the top right corner. The main content area shows "Name" as "Main Admin". There are three input fields: "Old Password", "New Password", and "Retype". To the right of the "New Password" and "Retype" fields are "Enter" and "Cancel" buttons respectively. At the bottom, there is a menu bar with "Files", "Run", "Options", and "Help".

5.13 Protection of Data

Programs can be protected if they are saved in a directory.

Are the programs not put in a directory they are useable for EVERYONE. The directory (folder, person, and group) can be protected for specific person. Requirement is the activation of the user management by an administrator. The administrator has the right to allocate and combine rights for folder, persons, and groups. Following rights are possible: a) Read & Start, b) Write & Delete c) Change Rights.

A logged in user can see the part of the directory with Read & Start Right. All there parts and folders of the directory are invisible.

Protection of directories

1. Tap on the menu strip **Files**.
2. There appears another menu strip with the functions: New, Edit, Copy and Delete
3. Tap on **Edit**.
4. There appears a new window with the directory. The administrator can see all folders.

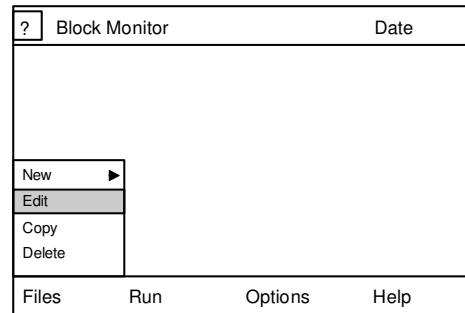

5. Tap on the folder, person, or group. This will be blue underlined.
6. Tap on **Edit**.

7. There appears a new window:
Edit directory.
Tap on Rights.

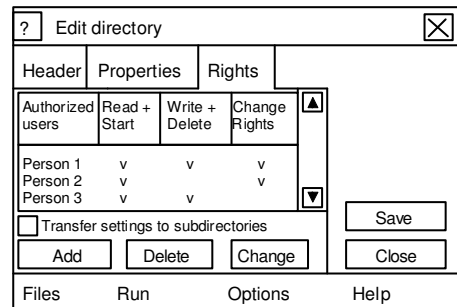

8. When the account is not protected, you will see that group of authorized users is EVERYONE. anybody as the right to Read + Start, to Write + Delete, and to Change Rights.

9. Tap on **Delete**. The authorized user EVERYONE is deleted.

10. Tap on **Add**. There appears a window where the users are listed. Tap on one or more users. The users are blue underlined. Tap on **Enter**.

11. There appears a new window. Taping on **Change** can combine the different rights. The Read and Start rights persist in any cases.

12. Tap on **Save** and **Close**.

5.14 Remote Log In & Data Transfer between 2 Labcyclers

Every user has the possibility to transfer data from one Labcycler to another independent on type of Labcycler. Both devices must be connected with a RS232 cable offered from SensoQuest as Inter-System-Copy-Cable. The directory of the other device is shown in green letters.

In case that no user management is installed all data or parts can copied without any limitation.

In case of installed user management only data which are visible for everyone can copied without any limitation. Protected data can only transferred after the user makes a Remote Log In. However, while the remittance the access rights will be lost. In case of the user management shell be saved a full data transfer can optional used.

Remote Log In & Copy of Data

1. Tap on menu strip **Options**.
2. There appears another menu strip with the functions: Settings, Remote Log In, Remote Log Out and Diagnosis.
3. Tap on **Remote log In**.

Block Monitor		Date	
New Cycler		Lid	Temp
Ready			
Temperature			
Block		Settings	
		Remote Log In	
		Remote Log Out	
		Diagnosis	
Files	Run	Options	Help

If the Remote Log In is deactivated, there will be not contact with the other Labcycler or another user is logged in. If there is no user management at the other device installed the Remote Log In will not necessary.

4. There appears a new window: Remote Login: Chose a user and put the specific password in. Confirm twice with **Enter**.
5. There appears for a short moment a new window: Login successful! And at the other Labcycler appears a new window with remote logged in user. Tap on **OK**

After the successful Remote Log In, the directory of the other Labcycler is shown in green letters. You can mark the parts of the directory. These parts get a blue background. Tap on **Copy**, and chose the part through tapping of your directory where this copied part should be put in. When the target directory is chosen tap on **Paste**. All copied data must get a new password protection in cases of necessity. The structure of the user management is not conserved. If there is any interest in the complete user management of the other device a full data transfer must be done (see full data transfer).

Remote Log Out

1. Tap on menu strip **Options**.
2. There appears another menu strip with the functions: Settings, Remote Log In, Remote Log Out and Diagnosis.
3. Tap in Remote Log Out.
4. There appears a new window: User logged off!
5. Tap on **OK**.

Block Monitor		Date	
New Cycler		Lid	Temp
Ready			
Temperature			
Block		Settings	
		Remote Log In	
		Remote Log Out	
		Diagnosis	
Files	Run	Options	Help

If the Remote Log In is deactivated, the Remote Log In was interrupted.

Full Data Transfer

The Full Data Transfer offers the possibility to transfer the complete directory inclusive the user management to another Labcycler.

Important: The Full Data Transfer deletes all data and the directory of the target Labcycler. It is mainly used to install new devices in case that old devices are present. Therefore customer need not install the programs running on the old device.

First of all both the Labcyclers must be connected with a RS232 cable offered at SensoQuest as Inter-System-Cop-Cable. Only the main administrator can start the Full Data Transfer, and the Main admin must be logged in before starting this process.

1. Tap on menu strip **Options**.
2. There appears a new menu strip.
3. Tap on **Diagnosis**.
4. There appears a new window: Service portal.
Put in the service code *777*. Confirm with **Enter**.
5. Tap on **Copy**.
6. Tap on **Receive**.
7. There appears a new window: Receive
Warning:
All data of this Labcycler will be overwritten by data transmission. Do you really wish to switch on the receive state?
8. Confirm with **Yes**.
9. Repeat point 1 to 5 at the transmitter Labcycler.
10. Tap on **Send** and confirm.

?		Block Monitor	Date
New Cycler		Lid	Temp
Ready			
Temperature			
Block		Settings	
		Remote Log In	
		Remote Log Out	
		Diagnosis	
Files	Run	Options	Help

The transmission starts!

6.1 Order information

Product	Order number
Labcyler Gradient Without block	011-101
Labcyler Basic Without block	011-103
Inter System Copy Cable	011-702
Gradient- Up Grade	011-801
Thermoblock 384 For microtiterplates 384-well	012-101
Thermoblock 48 For reaction tubes of 0.5 ml	012-102
Thermoblock 96 For reaction tubes of 0.2 ml and microtiterplates 96-well	012-103
Sealing pad for Thermoblock 384	012-701
Labcyler 48	013-101
Labcyler 48 Gradient	013-102
Labcyler 48s Gradient	013-104

7.1 Index

+ Column	3.1.1	Online Monitoring	3.5
? Key	1.1 & 1.8	Opening	1.2
- Key	1.9	Opening (case of emergency)	4.3
x Key	1.9	Options	1.6 & 1.7
- Symbol	2.2	Order Information	4.9
+ Symbol	2.2	Order Number	4.9
Administrator	5.3-5.5	Password	5.4 & 5.12
Article Number	4.9	Pause	3.7 & 3.8
Blocks	4.8	Power Consumption	4.8
Block Changing	4.1	Power Failure (Re-Start)	3.10
Capitalization	2.1 & 3.1	Power Supply	1.4
Cleaning	4.4	Program	3.1-3.10
Compatibility Tubes	4.5	Program Capacity	4.8
Cooling Rate	3.1.2 & 4.8	Program Edit	3.2
Copy File	2.2	Program New	3.1
Copy Program	3.3	Program Runs	3.1
Date Input	1.7	Program Steps	3.1
Delete File	2.4	Protocol	3.10
Delete Program	3.4	Purification	4.4
Delete Program Step	3.2	Reaction Tubes	4.5
Dimension	4.8	Return Step	3.1
Display	4.8	Run	3.5
Directory	2.1-2.4	Scope of Delivery	1.1
Directory Selected	2.1	Scope of Supply	1.1
Error Window	1.9 & 3.1	Scroll Bar	1.9
Fast Control	3.1	Seconds Input	3.1
Files	2.1-2.4	Self Test	1.5
File Edit	2.2	Set up	1.3
File New	2.1	Safety Instruction	4.6
Folder	2.1	Special Characters	2.1 & 3.1
Gradient	3.1.1 & 4.8	Start window	1.5 & 1.9
Guarantee	4.7	Start Program	3.5
Heated Lid	4.2 & 4.8	Stop Program	3.6
Heating Rate	3.1.2 & 4.8	Technical Data	4.8
Help	1.5 & 1.8	Temperature	4.8
Homogeneity	4.8	Temperature Input	3.1
Hours Input	3.1	Temperature Gradient	3.1.1
Initial Start up	1.5	Temperature In(de)crements	3.1.3
Insert Program	3.3	Temperature Run	3.5
Insert Program Step	3.2	TFT-Monitor	1.1 & 1.5
Interfaces	4.8	Touch-Field	1.5
Keyboard	1.2 & 4.8	Time Input (Local Time)	1.7
Language Set up	1.6	Time Input (Program)	3.1
Lid Control	4.2	Time In(de)crements	3.1.4
Lid-unbolting-key	1.2 & 4.1	Touch-Pen	1.5
Line Voltage	1.4 & 4.8	Touch Screen	1.5
Loops	3.1	User	5.7-5.12.
Loudness	4.8	User administration	5.1-5.2
Menu bar	1.5	Virtual Keys	4.8
Microtiterplates	4.5	Warranty	4.7
Minutes Input	3.1	Window Structure	1.9
Online-Help	1.8	Weight	4.8